

KMS-1122MLH

SERENITY SERIES

CUBER ICE MACHINE

Item # _____

Project: _____

Qty: _____
*AutoCad available on KCL

KMS-1122MLH
McDonalds, Be M, 2/13
Item # 13321

CUBER DIMENSIONS W x D x H

KMS-1122MLH
22 x 18 x 31^{1/4}



CONDENSING UNIT DIMENSIONS W x D x H

Installation Dimension*
SRK-12H3
52^{3/8} x 19^{1/2} x 43
*Dimensions include legs

Actual Dimension
SRK-12H3
50 x 17 x 28



KMS-1122MLH
Remote Air-Cooled

- Up to 1120 lbs. of ice production per 24 hours
- Ice on beverage design
- Less heat in the kitchen
- Minimized noise
- Durable stainless steel exterior (including rear panel)
- Individual crescent cube
- CycleSaver® Design 
- EverCheck® alert system 
- Stainless steel evaporator
- CFC / HFC Free foam
- R-404A Refrigerant

* The KMS-1122MLH is ENERGY STAR qualified.



Warranty

Valid in United States, Canada, Puerto Rico, & U.S. Territories. Contact factory for warranty in other countries.

Three Year - Parts & Labor on entire machine.

Five Year - Parts & Labor on: Evaporator.

Five Year - Parts on: Compressor, air-cooled condenser coil.



Hoshizaki

KMS-1122MLH SERENITY SERIES

DIMENSIONS
W x D x H
KMS-1122MLH
22 x 18 x 31^{1/4}

REMOTE AIR-COOLED / SRK-12H3

Water Temp° F.	50°	70°	90°
Air Temp° F.	70°	1085	1016
	80°	1093	958
	90°	1085	1000

UTILITY CONSUMPTION

Model Number	Ice Production Per Cycle		KWH per 100 LBS.	Potable Water Gal. per 100 lbs.	Condenser Water Gal. per 100 lbs.
	Lbs.	Cubes			
KMS-1122MLH with SRK-12H3	17.1	880	4.6	18.5	N/A

SPECIFICATIONS

Model Number	Condenser	Amperage	Min. Circuit Ampacity	Shipping Weight
KMS-1122MLH with SRK-12H3	Remote Air-Cooled	10.5	20	150 lbs. 275 lbs.

KM CUBE DIMENSIONS

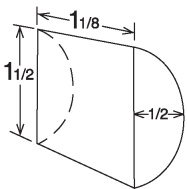

ELECTRICAL & PLUMBING / KMS-1122MLH

- 115V/60/1 - Voltage supply for the KMS Ice Maker is supplied from the SRK Remote Condenser
- 1/2" FPT copper or equivalent independent potable water supply
- 3/4" FPT independent drain connection

CONDENSER UNIT / SRK-12H3

- 208-230/60/3
- 20 amp Max Fuse/HACR Breaker Size

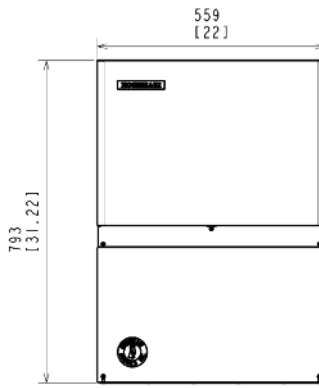

FRONT VIEW

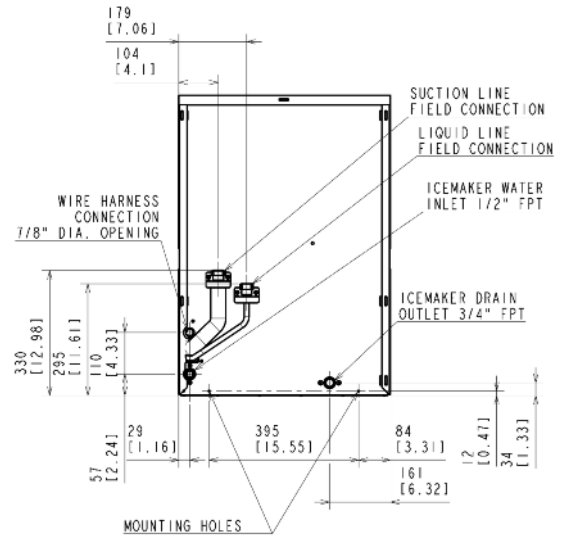

BACK VIEW

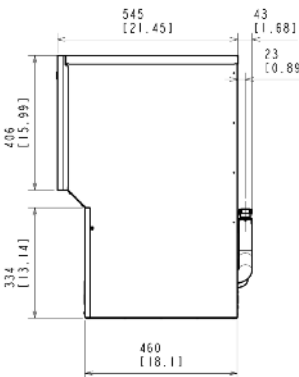

SIDE VIEW

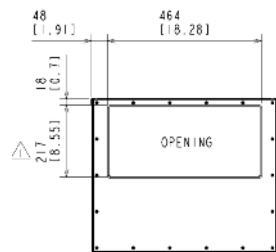

BOTTOM VIEW

SRK-12H3 Remote Condensing Unit (Sold Separately)
For Use with KMS-1122MLH

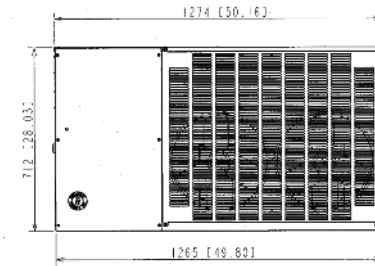

FRONT VIEW

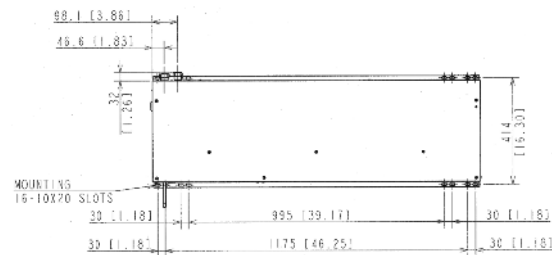

TOP VIEW

Pre-Charged Tubing Kits
(Sold Separately)
• 20' R404-20810
• 35' R404-35810
• 55' R404-55810



Voltage supply for the KMS Ice Maker is supplied from the SRK Remote Condenser.

OPERATING LIMITS

- Ambient Temp Range 45 - 100°F
- Water Temp Range 45 - 90°F
- Water Pressure 10 - 113psig
- Voltage Range 104 - 127V - Voltage supply for the KMS Ice Maker is supplied from the SRK Remote Condenser

SERVICE

- Panels easily removed and all components accessible for service.

CONDENSING UNIT

- Voltage Range 187 - 253V
- Ambient Temp Range -20 - 122° F



© HOSHIZAKI AMERICA, INC.

618 Hwy. 74 S., Peachtree City, GA 30269

TEL 1-800-438-6087

FAX 1-800-345-1325

www.hoshizaki.com

Printed in U.S.A.

